

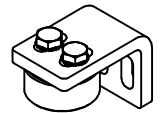

PIVOT FERME PORTE INTEGRATED DOOR CLOSER 25312DT52 / 25312GT52



NOTICE DE MONTAGE : NM 25312-52

Dimensions possibles de la porte / possible door size :

Hauteur / height : 2000 mm MAX

Largeur / width : 1000 mm MAX

Cadre / frame : tube □ 40x40 mm MIN

Poids de la porte / door weight : 80 Kg MAX

Force de fermeture / torque : 15,7 N.m

Angle d'ouverture / opening angle : 180° MAX

Sens d'ouverture / opening side :

DROITE / RIGHT

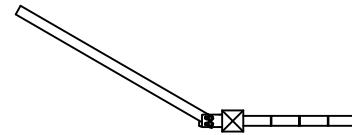

GAUCHE / LEFT

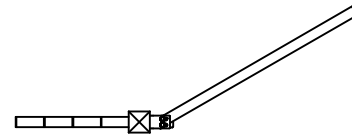

Vue d'ensemble et cotes d'implantation / Overview and mounting dimensions

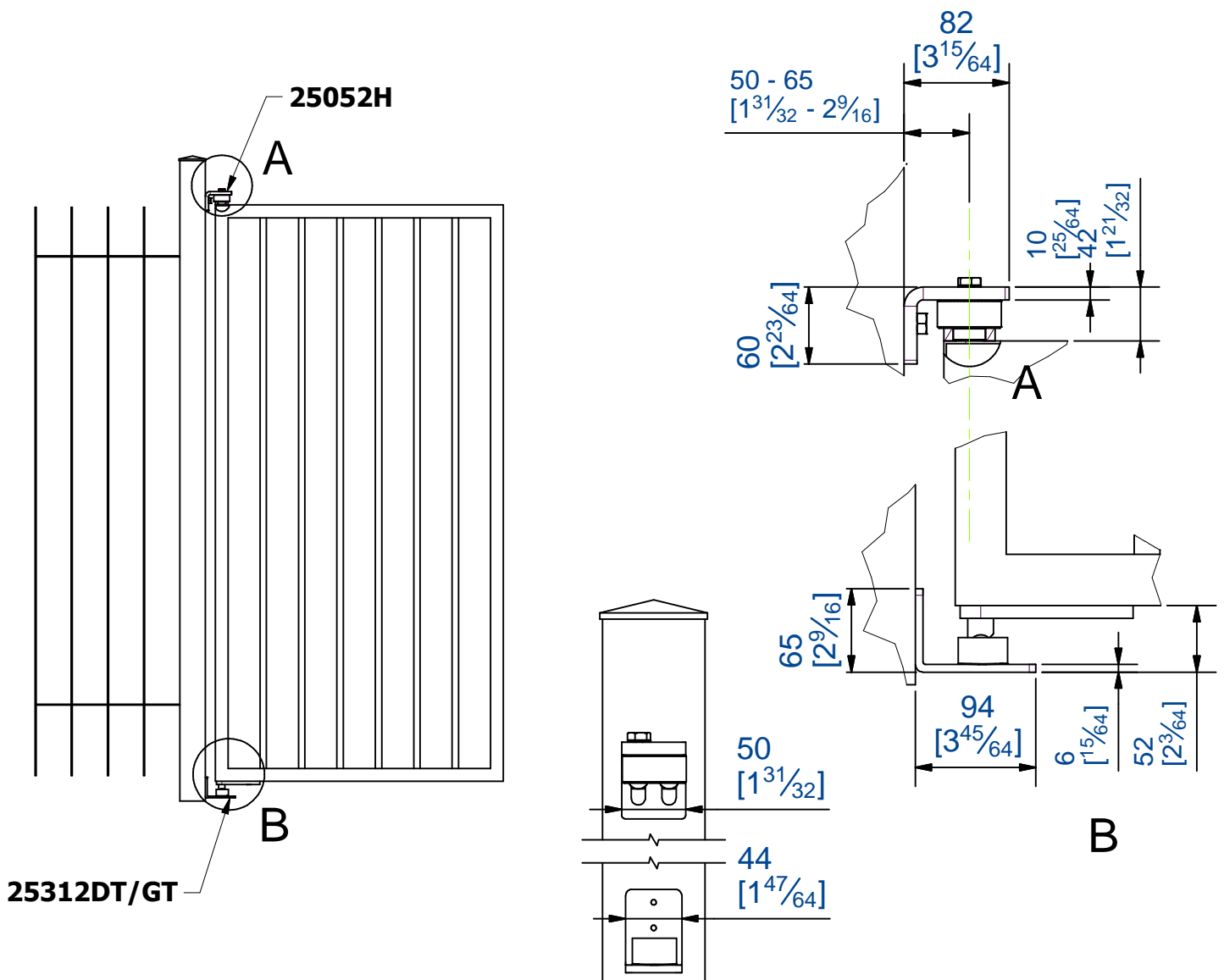

Fabrication du panneau / construction of the door

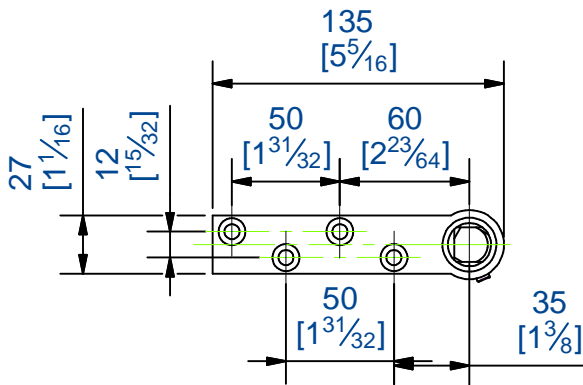
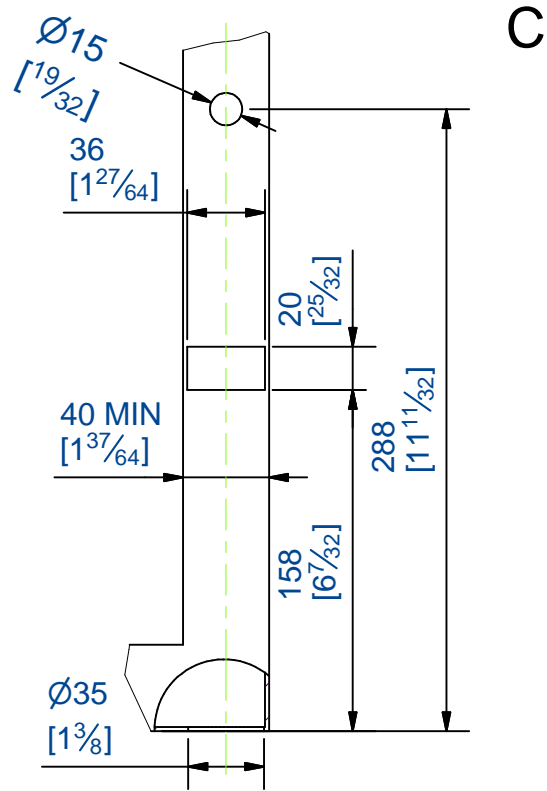
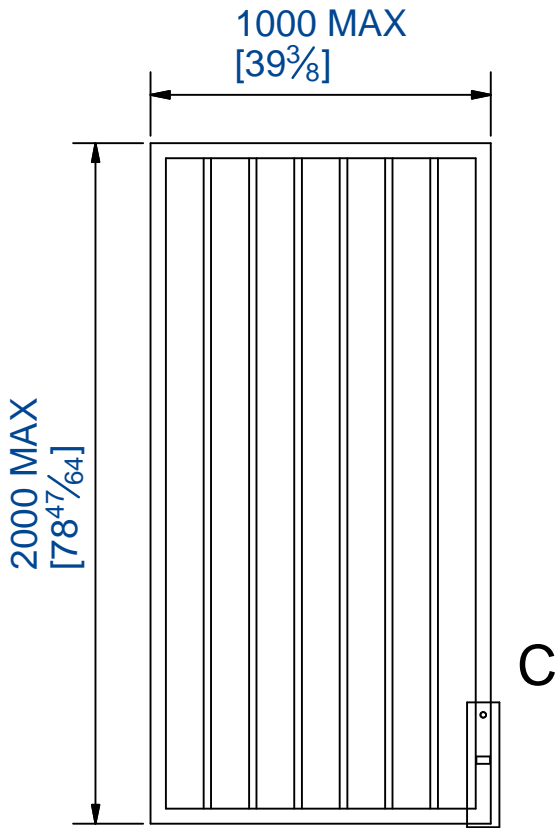

Non fourni
Not supplied

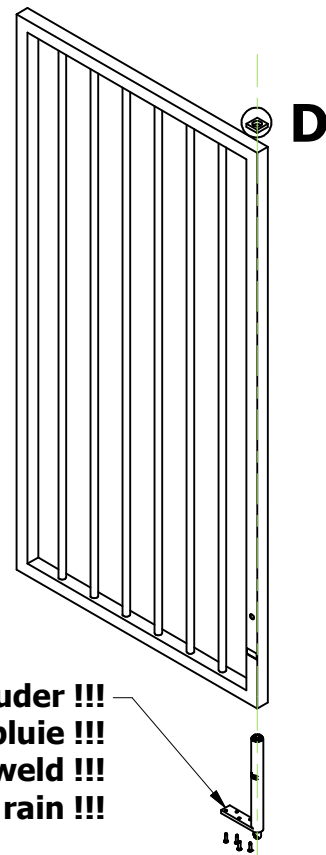
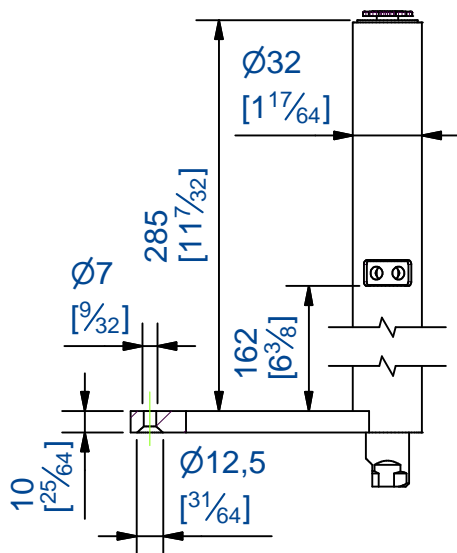
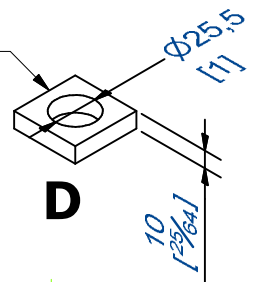

Ne pas souder !!!
Ne pas exposer à la pluie !!!
Do not weld !!!
Do not expose to rain !!!

Montage / assembly

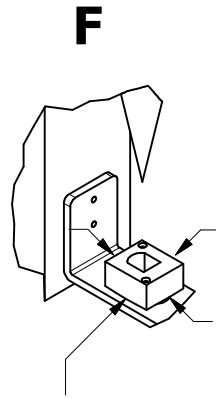
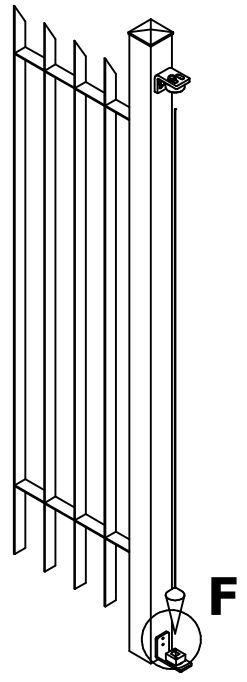
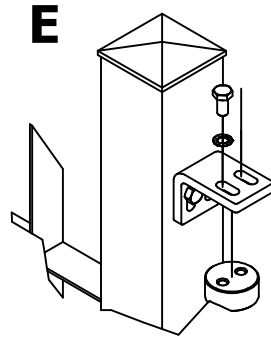
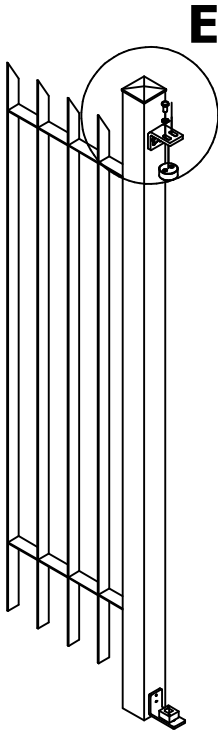
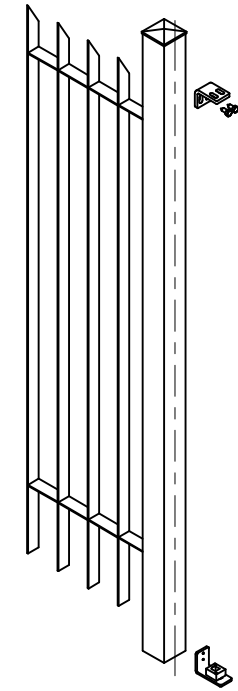

**Immobiliser par soudure
Immobilize by welding**

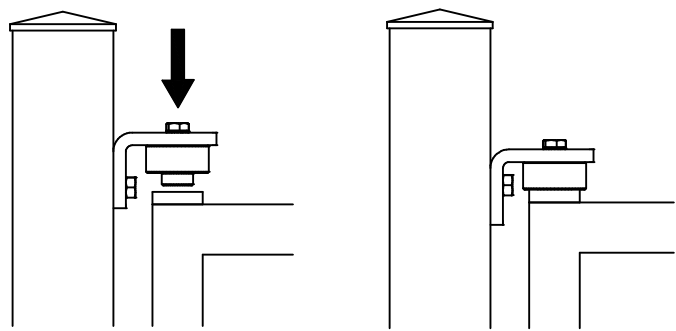
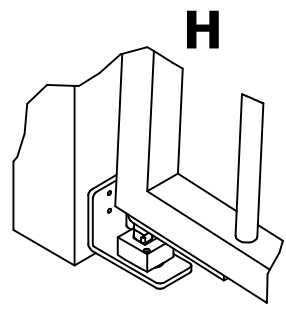
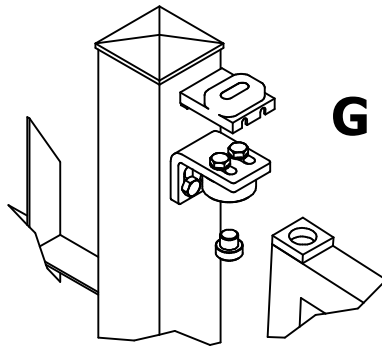
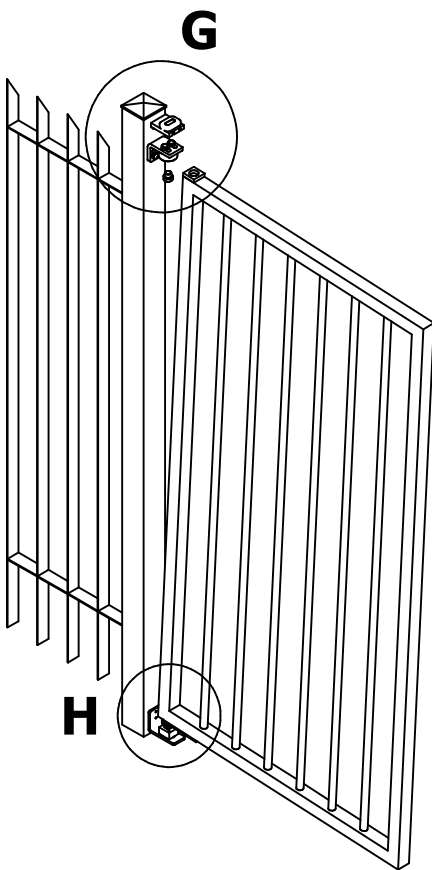

Réglage du ressort / torsion spring adjustment

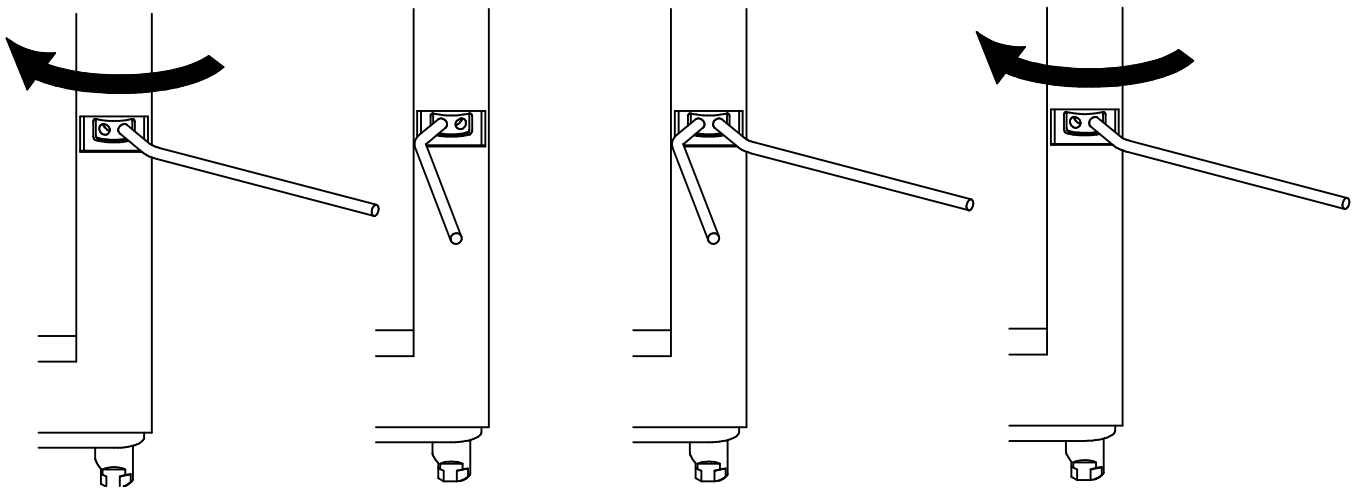

Insérer la goupille dans le 3ème trou
Insert the pin in the 3rd hole

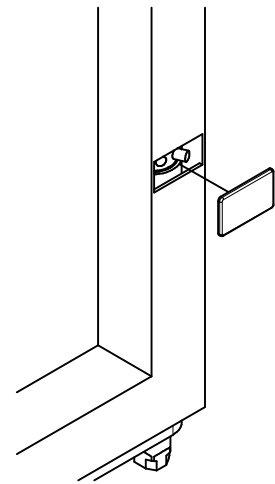

Réglage de la vitesse / speed gear adjustment

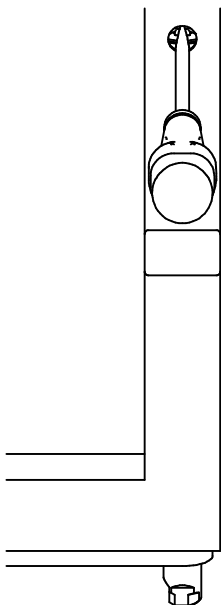

Rapide
Faster

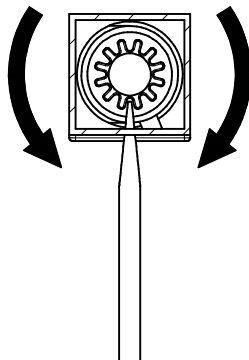

Lent
Slower

