

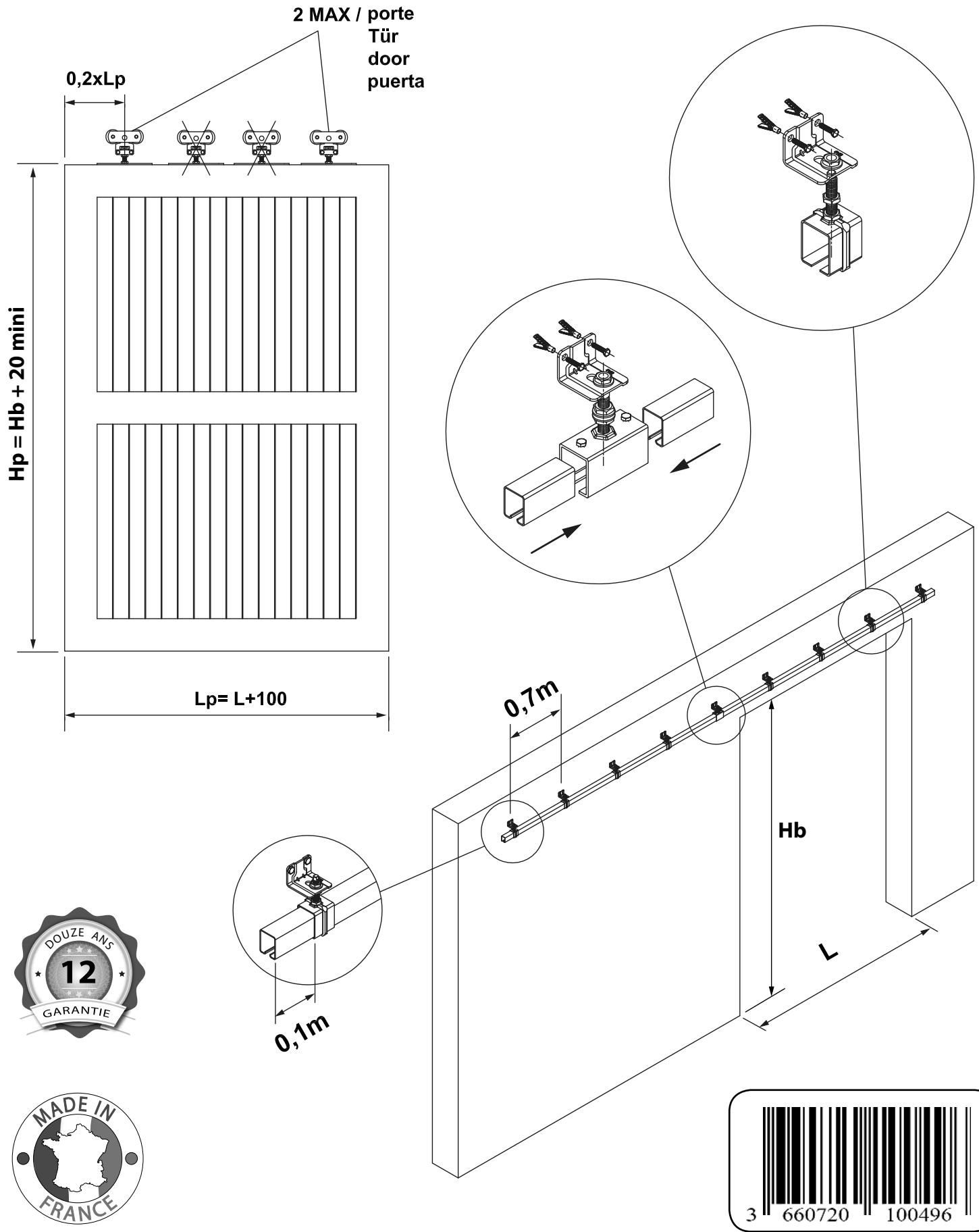

NOTICE DE MONTAGE
MONTAGEANLEITUNG
INSTRUCTIONS FOR ASSEMBLY
INSTRUCCIONES DE MONTAJE

SPORTUB NM_SPORT_007



	D min/max	H mini
3530GV	18/30	170
5040GV	26/45	200

