

Ferme-porte  
 Poids du portail : 200Kg  
 Ouverture gauche  
 Pour tube: □50mm

Door closer  
 Gate weight : 200Kg  
 Left opening  
 Tubular section: □50mm

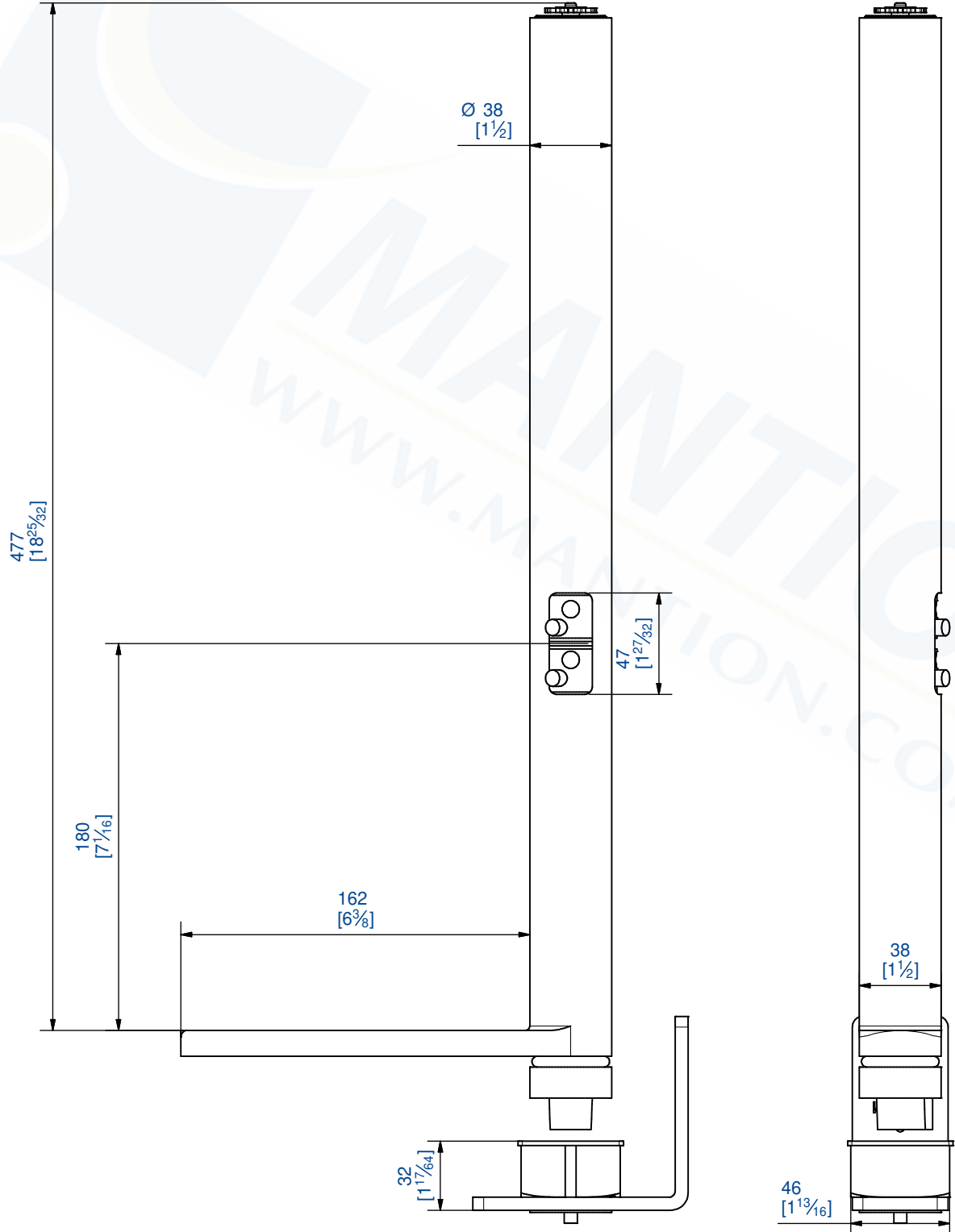
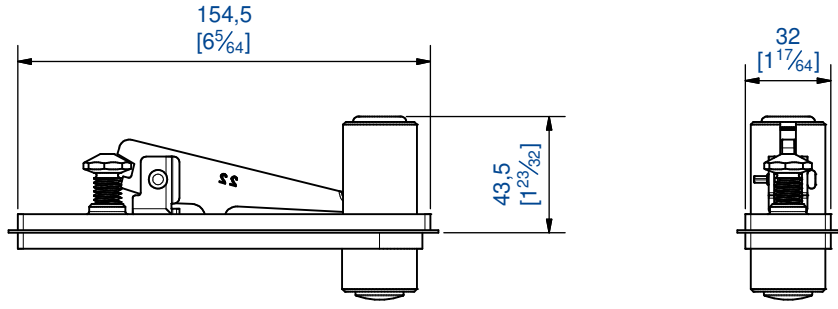

Référence Item Nr: **25322GT**

Rail associé  
 Combined track: