

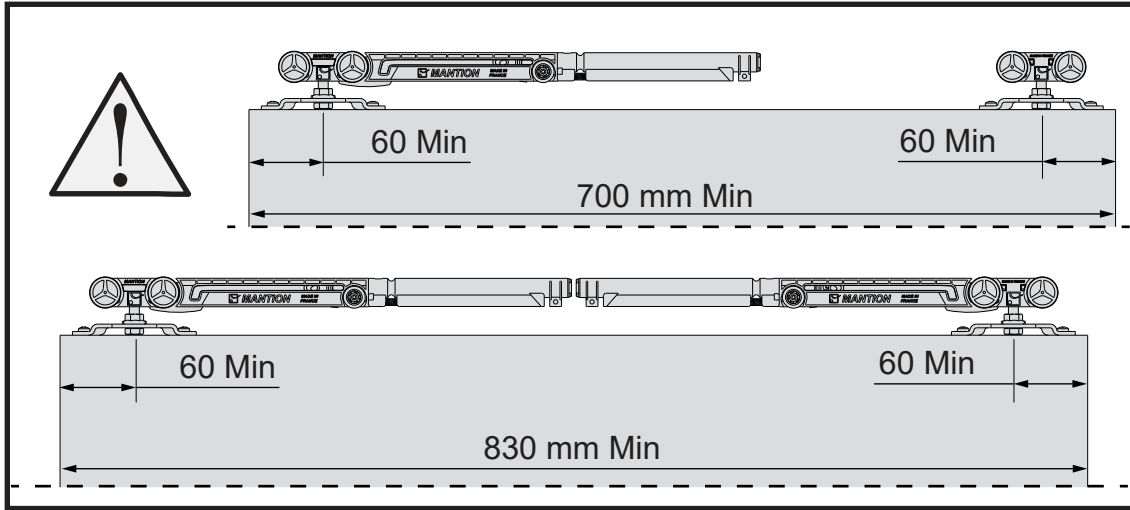

INSTRUCTIONS DE MONTAGE
MONTAGEANLEITUNG
INSTRUCTIONS FOR ASSEMBLY
INSTRUCCIONES DE MONTAJE



SAF®
M65S



Poids de la porte Gewicht der Tür Weight of the door
10-20 KG
Temperature d'utilisation Betriebstemperatur Operating temperature
10°C--> 50°C
Temperature de stockage Lagertemperatur Storage temperature
-20°C--> 80°C

1

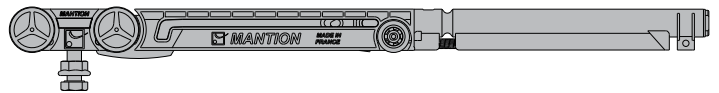
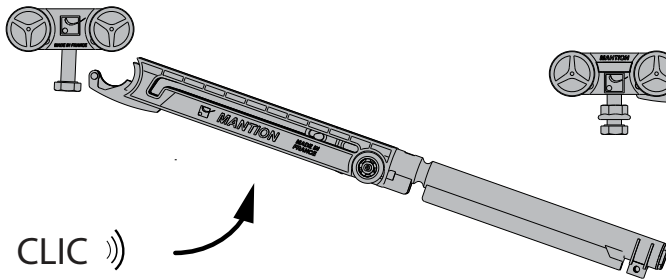

2

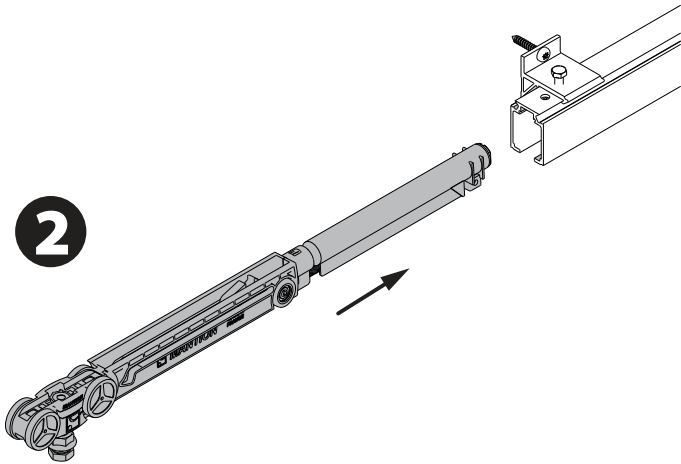

3

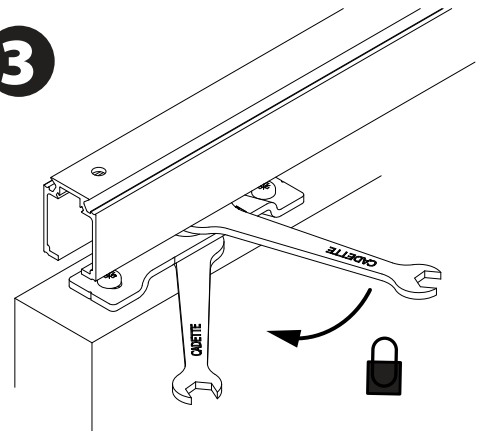

4

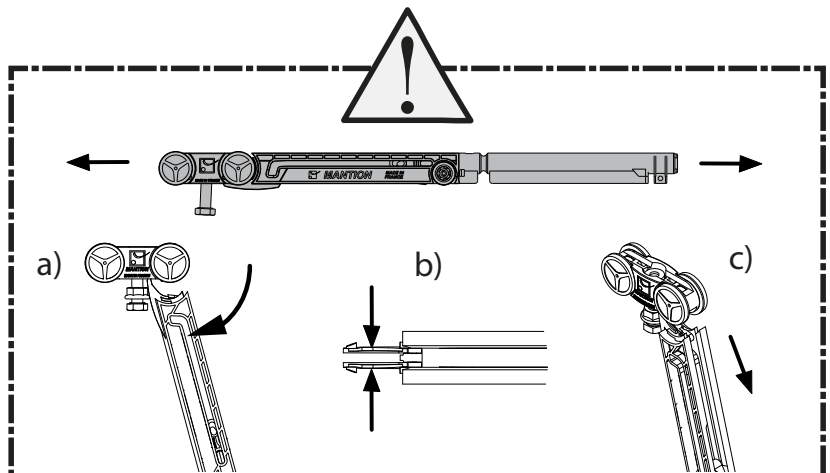
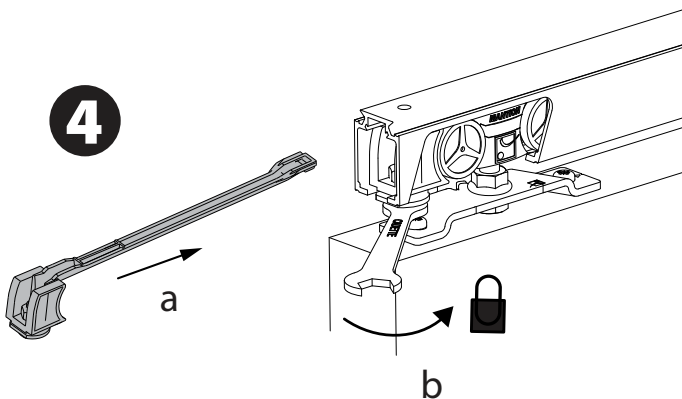



INSTRUCTIONS DE MONTAGE
 MONTAGEANLEITUNG
 INSTRUCTIONS FOR ASSEMBLY
 INSTRUCCIONES DE MONTAJE



SAF®-SLIM
M65S

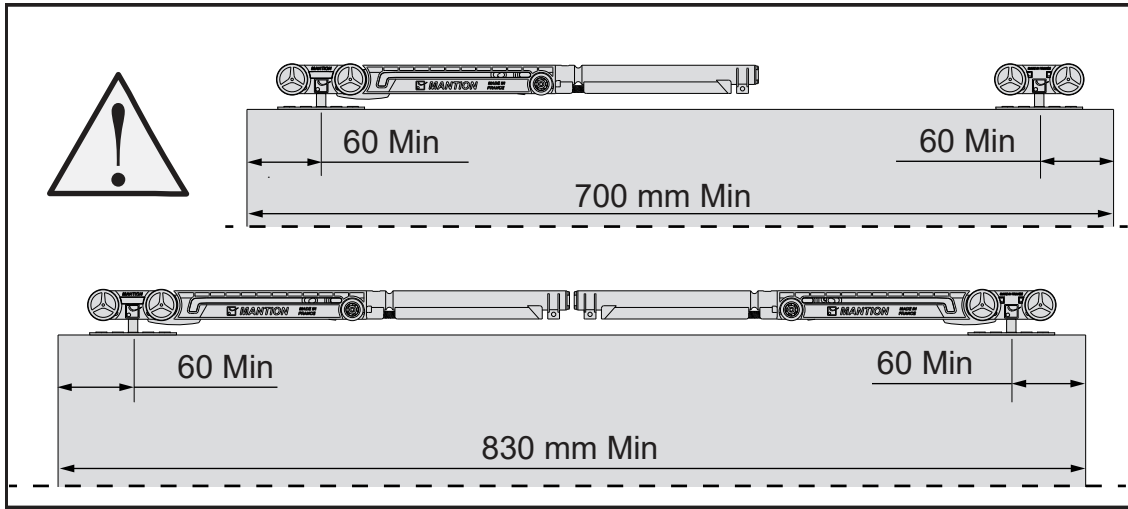

Poids de la porte Gewicht der Tür Weight of the door
10-20 KG
Temperature d'utilisation Betriebstemperatur Operating temperature
10°C--> 50°C
Temperature de stockage Lagertemperatur Storage temperature
-20°C--> 80°C

