

6 5 4 3 2 1

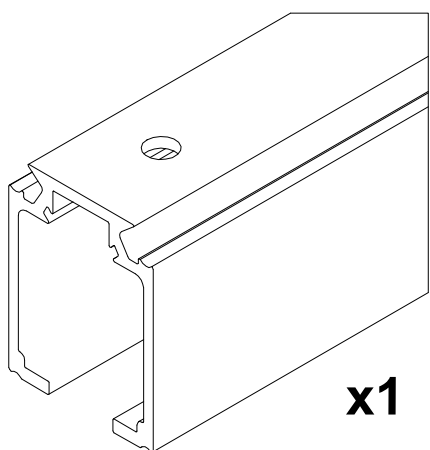

x1

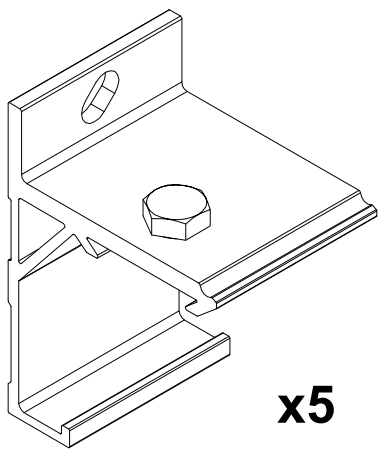

x5

Cartonnette couleur positionnée en bas du set, fixée par les agrafes et cartonnette intermédiaire 5 faces positionnée à 1,5m de hauteur (bord le plus haut), scotchée sur le rail. Embouts fixés par 4 agrafes.

label on the bottom of the set kept in position by staples and intermediate label; position high 1,5m, taped on the track. Each end tips closed by 4 staples.

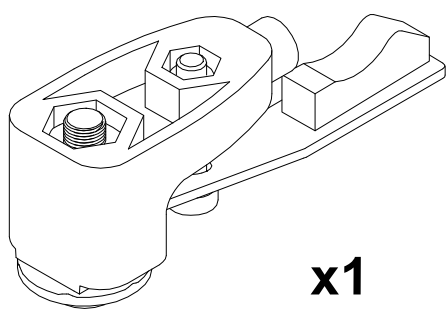

x1

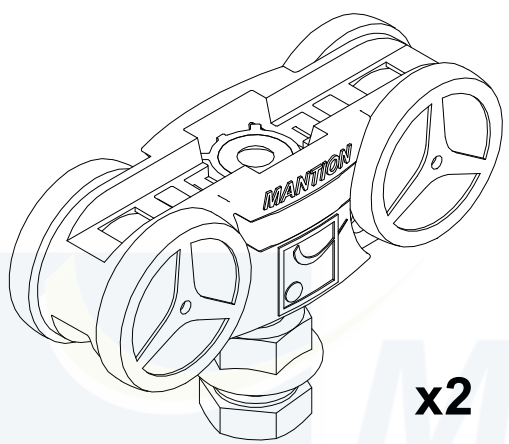

x2

Ensemble pour 1 panneau avec rail de 1m95, pour panneau de 21 à 60 kg maxi.

- Contenu :
- 1 rail 13108/195
 - 5 équerres fixation murale 13013
 - 2 montures 13218
 - 1 butées 11213
 - 1 ferme porte M66S
 - 2 platines fixation sur chant 13036
 - 1 guide 1103R
 - 1 Buly
 - vis de pose
 - Notice de pose

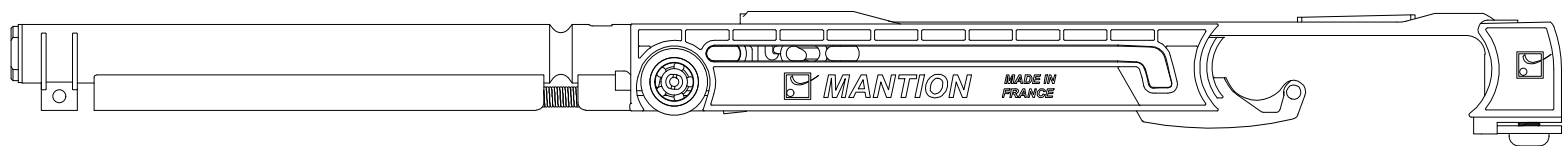

x1

Set for 1 panel with 1.95 m long track, capacity per panel : from 21 to 60 kg.

- Content :
- 1 track 13108/195
 - 5 wall-fixing brackets 13013
 - 2 hangers 13218
 - 1 stopper 11213
 - 1 damper closer M66S
 - 2 mounting plates 13036
 - 1 guide 1103R
 - 1 Buly
 - screws
 - instructions for assembly

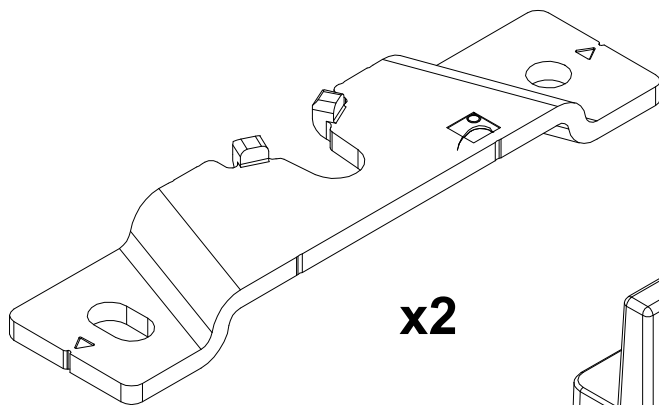

x2

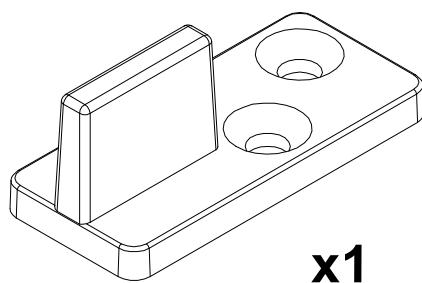

x1

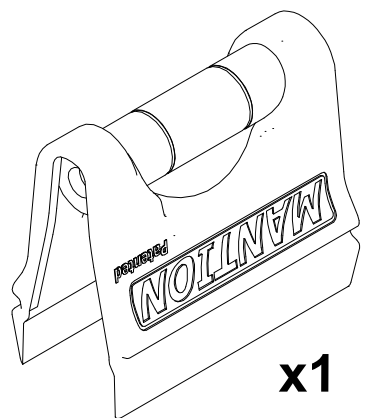

x1



7,rue Gay Lussac
25000 BESANCON

Référence
Item Nr:
SAF10-80-195-2

Range:
13108

6 5 4 3 2 1