

Rail aluminium anodisé pour paroi fixe
 Longueur coupée à la demande du client
 Longueur maxi 6m
 Poids 0.93 Kg / m

Anodized aluminum track for fixed wall
 Length can be cut according to customer's inquiry
 Max length 6m
 Weight 0.93 Kg / m

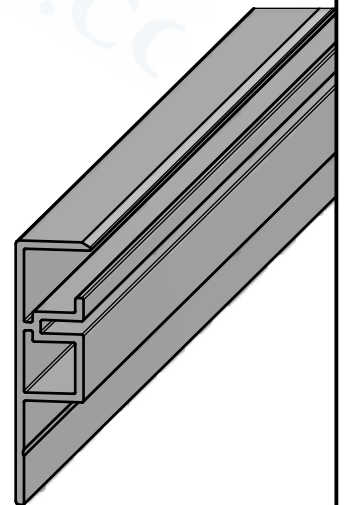
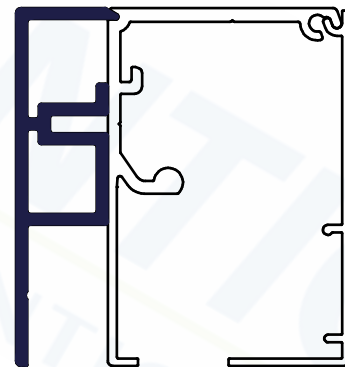
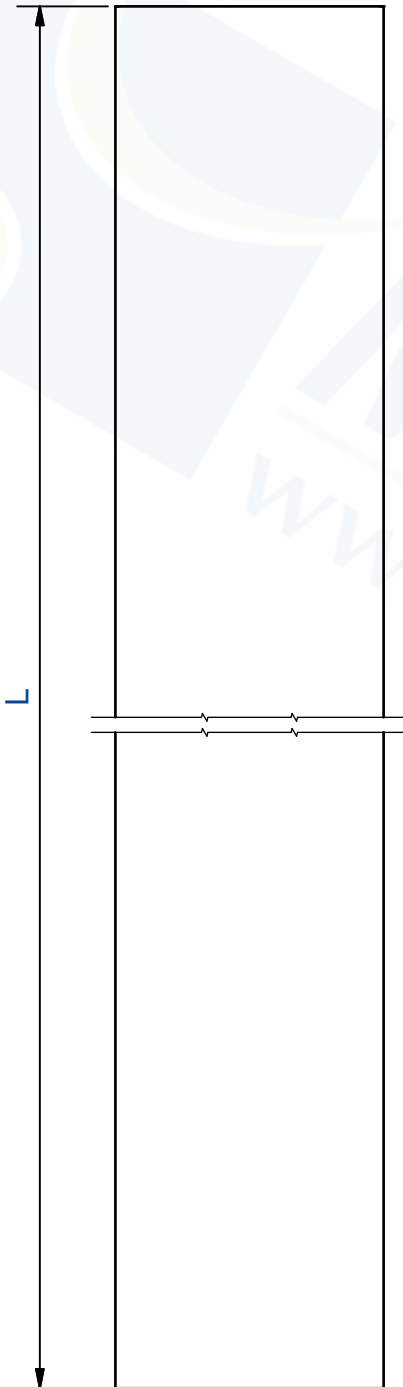

7,rue Gay Lussac
 25000 BESANCON

Référence
 Item Nr: **GB6312**

Rail associé
 Combined track: