

MANTION
SLIDING SYSTEMS

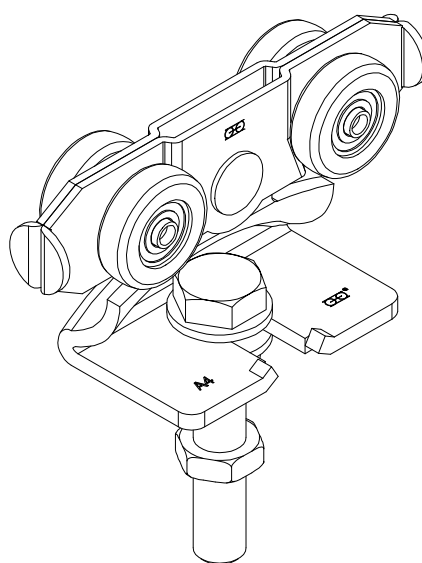

Monture fixation sur chant, 4 galets en acier inoxydable montés sur roulements à billes.
Matière : Acier inoxydable, 316L
Capacité : 400 Kg par panneau

Hanger with swanneck equipped with 4 steel wheels mounted on ball bearings.
Material : Stainless Steel, 316L
Maximum load : 400 Kg per panel



7,rue Gay Lussac
25000 BESANCON

Référence
Item Nr: **9242XSA4**

Rail associé
Combined track: **9040XA4**