



System for wardrobe doors

PICOSTAR 19®

For panel thickness of 19 mm

See details of the standard EN 1527 p.4

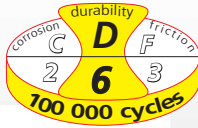

CAPACITY/PANEL	55 KG
TRACK	ALUMINIUM
MOVEMENT	STRAIGHT

SETS* packaged in PET tube

Item Nr.	Description
72/200A	Set of natural anodised tracks in 2 m lengths for 2 panels : - 1 aluminium set of upper and lower tracks + housing in 2 m. length - 1 aluminium finishing profile 61T of 2 m. length - 4 PICO59 rollers and 4 PICO59 guides - Screws and mounting instructions
72/200B	Ditto lacquered white (RAL 9016) finishing
72/300A	Set of natural anodised tracks in 3 m lengths for 3 panels : - 1 aluminium set of upper and lower tracks + housing in 3 m. length - 2 aluminium finishing profile 61T of 2 m. length - 6 PICO59 rollers and 6 PICO59 guides - Screws and mounting instructions
72/300B	Ditto lacquered white (RAL 9016) finishing

HANDLES 2.8 m long – packaged by 2 in PET tube

71E19/280A	Set of 2 anodized aluminium handles. Suiting for panels of 19 mm thickness. - 2.8 m. length
71E19/280B	Ditto lacquered white (RAL 9016) finishing
71G19/280A	Set of 2 anodized aluminium handles. Suiting for panels of 19 mm thickness. - 2.8 m. length
71G19/280B	Ditto lacquered white (RAL 9016) finishing
71V19/280A	Set of 2 anodized aluminium handles. Suiting for panels of 19 mm thickness. - 2.8 m. length
71V19/280B	Ditto lacquered white (RAL 9016) finishing
71H19/280A	Set of 2 anodized aluminium handles. Suiting for panels of 19 mm thickness. - 2.8 m. length
71H19/280B	Ditto lacquered white (RAL 9016) finishing

Components by piece:

SET OF UPPER AND LOWER TRACKS

70/600A	Aluminium set of upper and lower tracks + housing in 6 m. length
70/600B	Ditto lacquered white (RAL 9016) finishing

GEAR

PICO59	Gear for equipping 1 panel : - 2 rollers equipped with nylon rollers mounted on precision ball bearings - 2 guides equipped with nylon rollers mounted on precision ball bearings - Fixing screw and installation instructions	10
--------	--	----

FINISHING PROFILES in lengths of 2 m

61T/200A	Anodized aluminum profile (bottom of the door)- 2 m. length	8
61T/200B	Ditto lacquered white (RAL 9016) finishing	8

H-PROFILE FOR CREATING MULTI-PANEL DOORS

61H19/180A	Anodised aluminium H-profile for creating multi-panel doors. One cambered surface and one flat surface. Length = 1.8 m	8
61H19/180AM	Ditto delivered with 12 felt shims and 16 holding clips for adding a mirror section (not glued on a panel)	8

SETS PICOSTAR 19

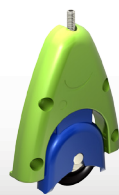

PICO59 roller



PICO59 guide

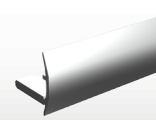

Finishing profile

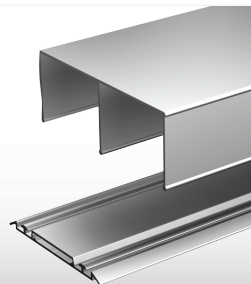

Set of tracks

PICOSTAR 19 HANDLES

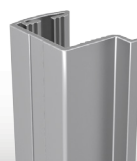

71E19/280A

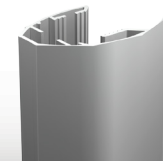

71G19/280A

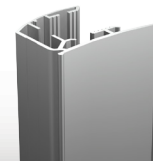

71V19/280A



71H19/280A

*Our handles are sold separately.

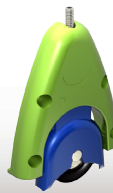

PICO59

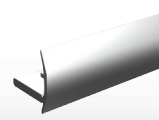
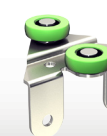

61T/200A



70/600A



61H19/180AM

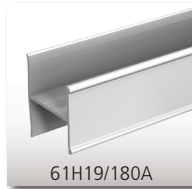
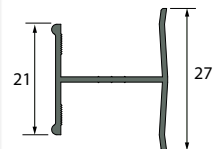

61H19/180A



Example for mounting a mirror section with a flat surface H-profile

Example for mounting a multi-panel door with a flat surface H-profile

Example for mounting a multi-panel door with a cambered surface H-profile

Top design range for the equipment of wardrobes and cupboards:

- **QUALITY:** The upper guide and roller are equipped with ball bearings for easy and silent motion
- **DESIGN:** Reversible upper track: one curved face and one flat face
- **SAFETY:** Antiderailing system on mountings
- **CONVENIENCE:** Damper closer system, keeps door closed
- **SLIDSOFT®:** online calculator

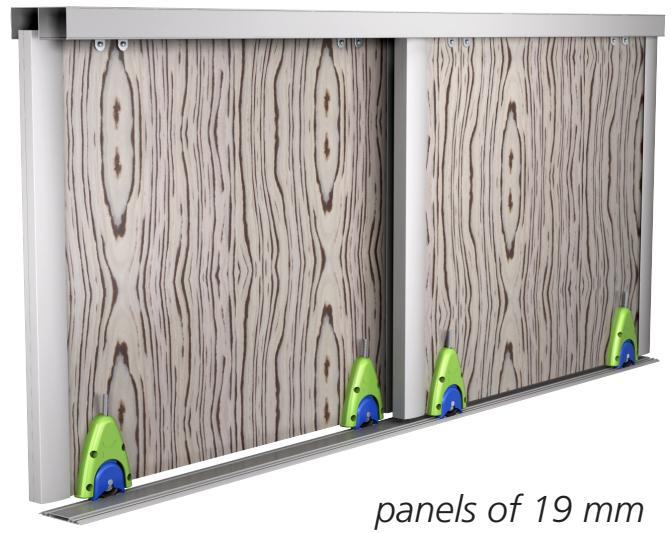

PICOSTAR 19®

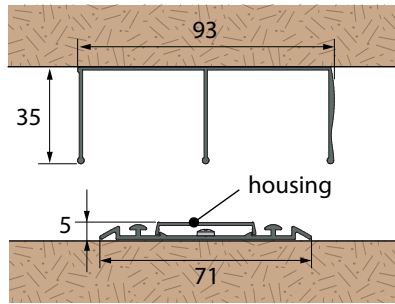

Set of PICOSTAR tracks
(2 - 3 - 6 m)

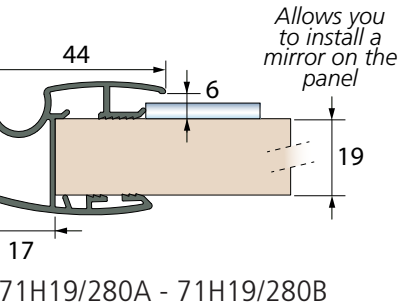
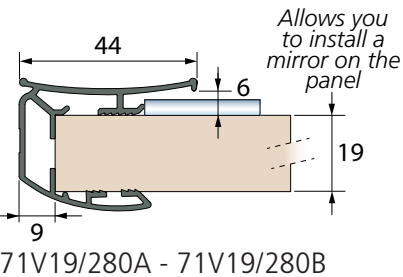
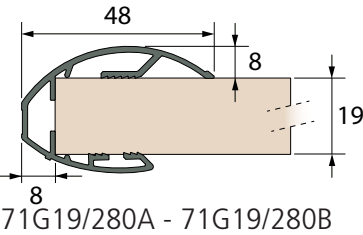
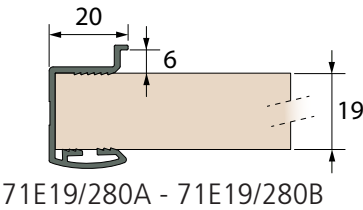

PICOSTAR 19®

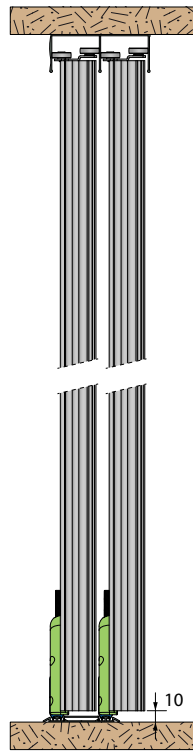

See accessories p.26

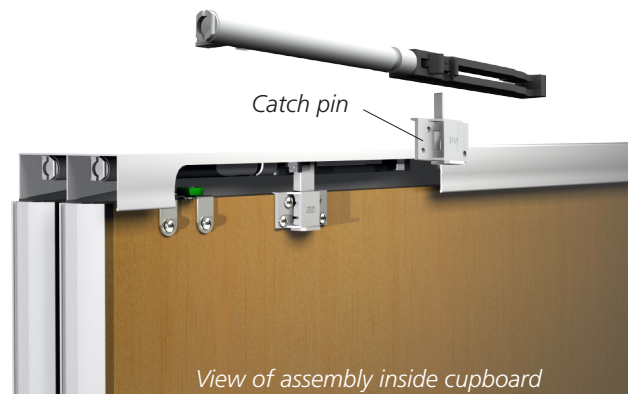
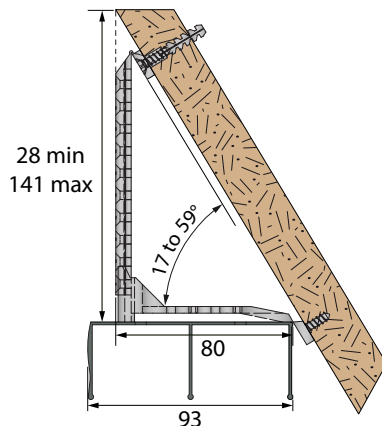

View of assembly inside cupboard